

Stackable columns can be of varying heights; shafts can be field cut to fit any non-standard opening.

Field Cutting May Be Required-Pieces To Be Cut To Fit

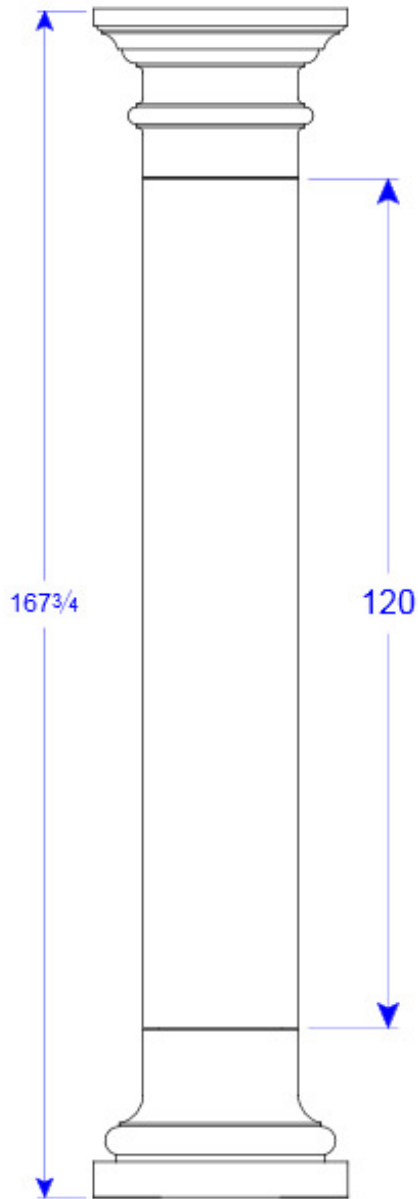

CLTS 22 x 120

Column
CLTS 22
CLTS 22 x 120

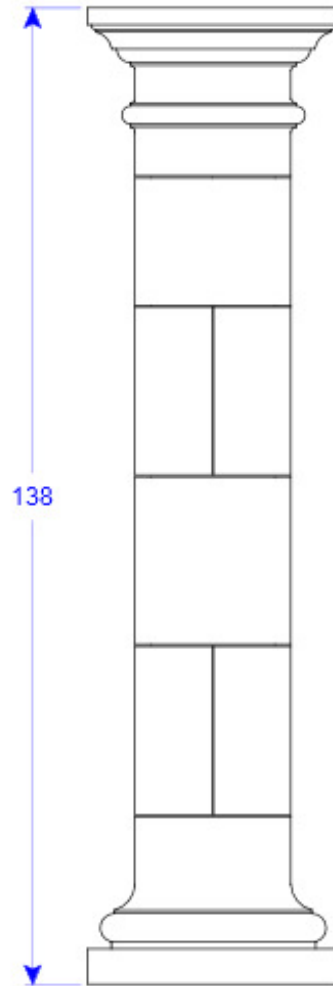

CLTS 22

Capital
35 1/2" x 23 3/4"H
35 1/2 x 23 3/4

Base
35 1/2" x 23 3/4"H
35 1/2 x 23 3/4

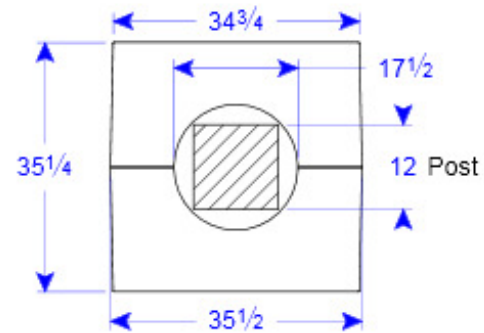
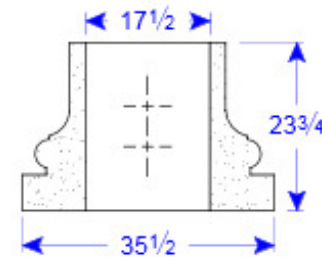
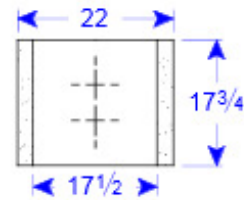
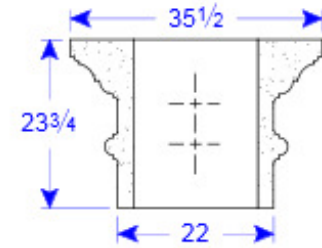
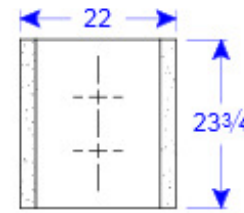

Shafts
22"OD x 18"H / 18"OD x 23 3/4"
22 OD x 120